

DAILY PROVISIONS - WEST VILLAGE, NYC

LANDMARKS PRESENTATION - DECEMBER 13th, 2018



rockwellgroup

NEW YORK CITY - SITE MAP

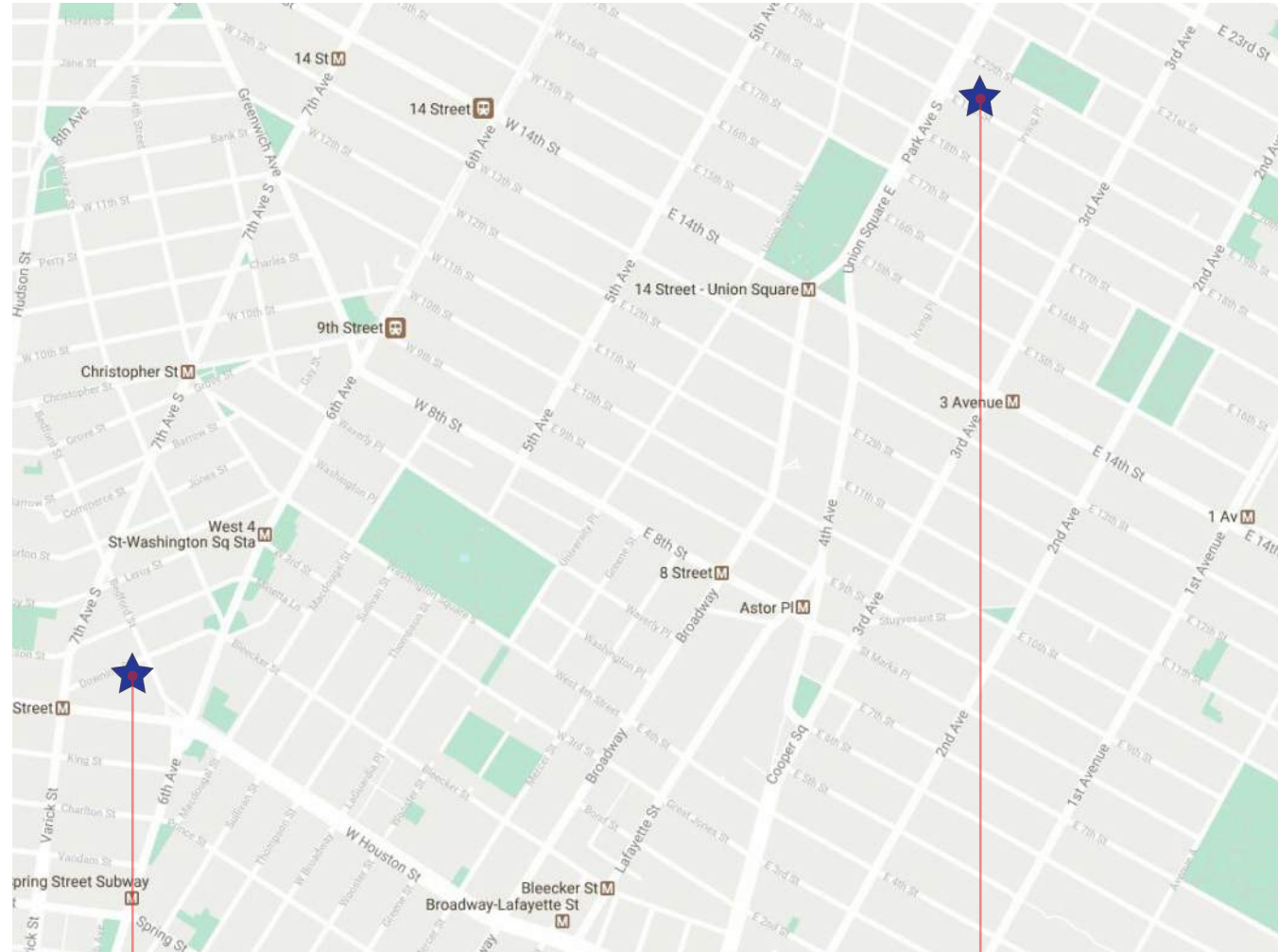

NEW SITE LOCATION:
29 BEDFORD ST

19TH STREET DAILY PROVISIONS

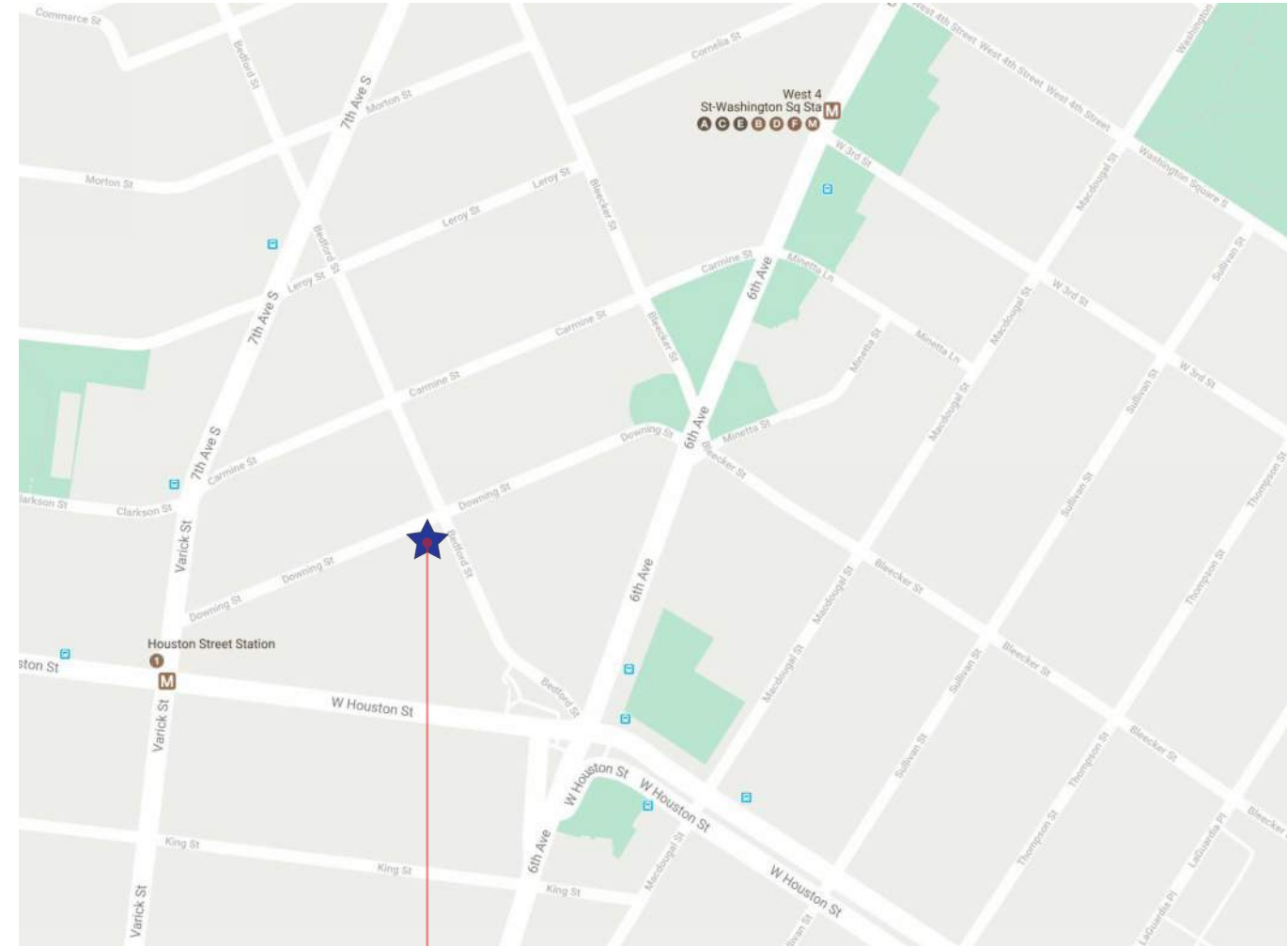

NEW SITE LOCATION:
29 BEDFORD ST

Daily Provisions : Site

LANDMARKS PRESENTATION

DECEMBER 13TH, 2018

rockwellgroup





Daily Provisions: 19th Street

LANDMARKS PRESENTATION

DECEMBER 13TH, 2018

rockwellgroup



UNION SQUARE
HOSPITALITY GROUP™



Daily Provisions: 29 Bedford Street

LANDMARKS PRESENTATION

DECEMBER 13TH, 2018

rockwellgroup



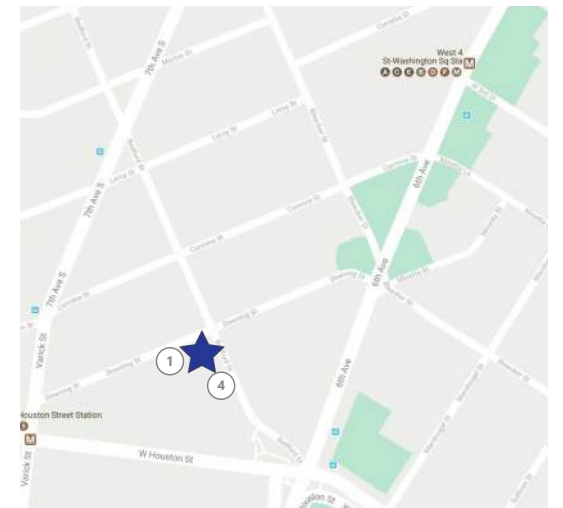

- ① Adjacent Buildings, Downing St.
- ② Blue Ribbon Bar, 34 Downing St.
- ③ Residential, 38 Downing St.
- ④ Adjacent Buildings, Bedford St.
- ⑤ Retail, 27 Bedford St.
- ⑥ Residential, 25 Bedford St.

Adjacent Buildings

LANDMARKS PRESENTATION

DECEMBER 13TH, 2018

rockwellgroup



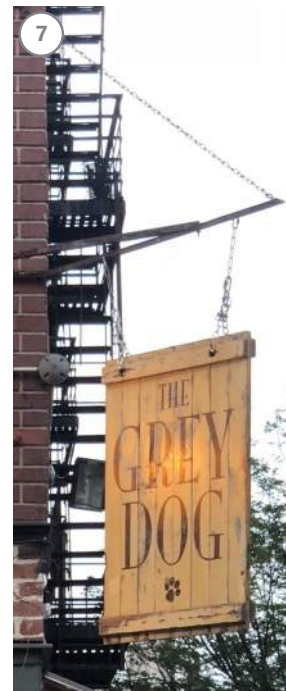
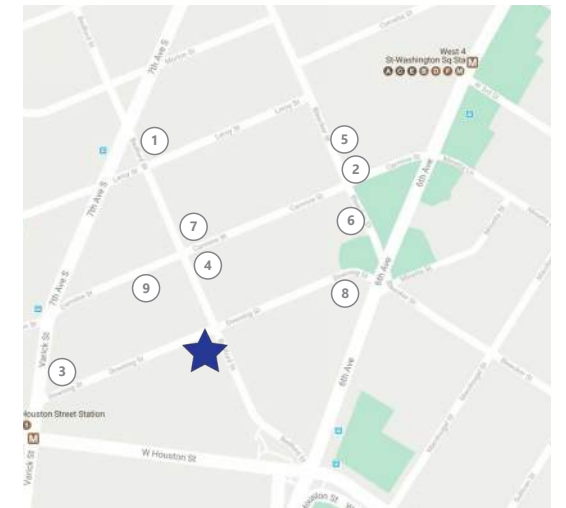

- ① Village Tavern, 46 Bedford St.
- ② Grom, 233 Bleeker St.
- ③ Vien, 220 Varick St.
- ④ Market Table, 54 Carmine St.
- ⑤ Murray's Cheese Bar, 239 Bleeker St.
- ⑥ Molly's Cupcakes, 228 Bleeker St.
- ⑦ The Grey Dog, 49 Carmine St.
- ⑧ Cafe Clover, 10 Downing St.
- ⑨ Emily, 35 Downing St.

Neighborhood Context

LANDMARKS PRESENTATION

DECEMBER 13TH, 2018

rockwellgroup





- ① Daily Provisions custom blue paint
- ② ADA entry ramp
- ③ brass railing
- ④ menu
- ⑤ existing window construction
- ⑥ new window construction
- ⑦ gooseneck fixture
- ⑧ blade sign
- ⑨ neon signage

29 Bedford St. Proposed Exterior Design

LANDMARKS PRESENTATION

DECEMBER 13TH, 2018

rockwellgroup





- ① Daily Provisions custom blue paint
- ② ADA entry ramp
- ③ brass railing
- ④ menu
- ⑤ existing window construction
- ⑥ new window construction
- ⑦ gooseneck fixture
- ⑧ blade sign
- ⑨ neon signage

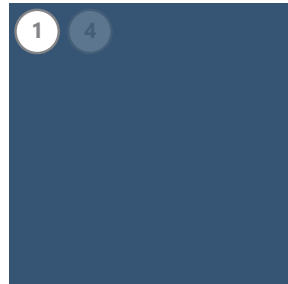

Daily Provisions blue paint

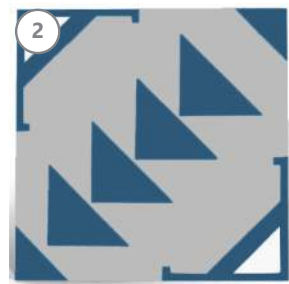

custom floor tile

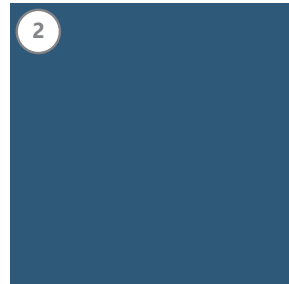

custom floor border tile

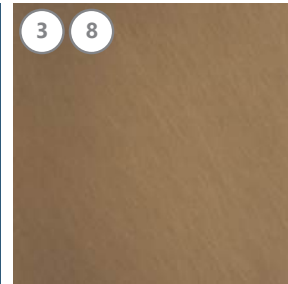

brass finish

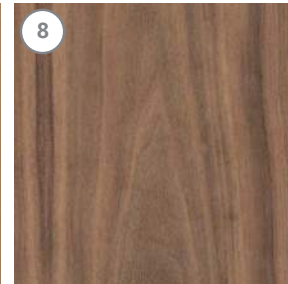

walnut finish



gooseneck fixture

Proposed Exterior Materials Palette

LANDMARKS PRESENTATION
DECEMBER 13TH, 2018



- ① Daily Provisions custom blue paint
- ② ADA entry ramp
- ③ brass railing
- ④ menu
- ⑤ existing window construction
- ⑥ new window construction
- ⑦ gooseneck fixture
- ⑧ blade sign
- ⑨ neon signage

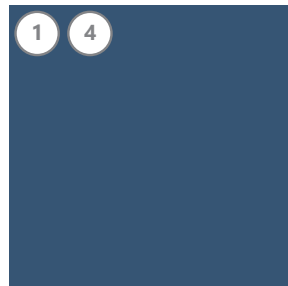

Daily Provisions blue paint

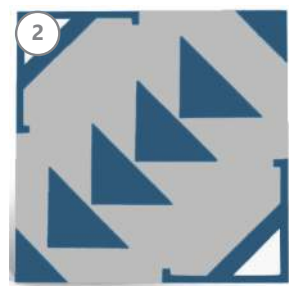

custom floor tile

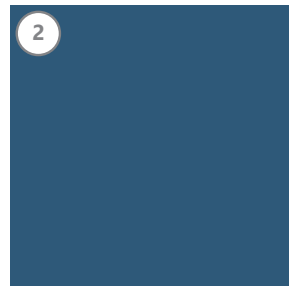

custom floor border tile

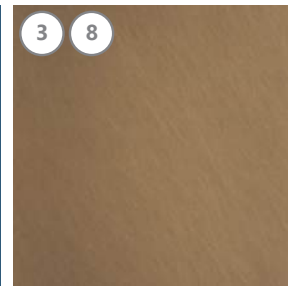

brass finish

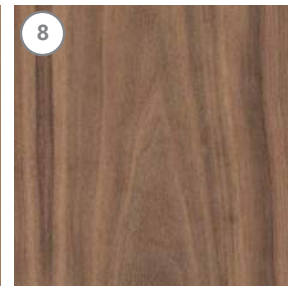

walnut finish



gooseneck fixture

Bedford St. Elevation - Materials Palette

LANDMARKS PRESENTATION

DECEMBER 13TH, 2018

rockwellgroup



UNION SQUARE
HOSPITALITY GROUP™

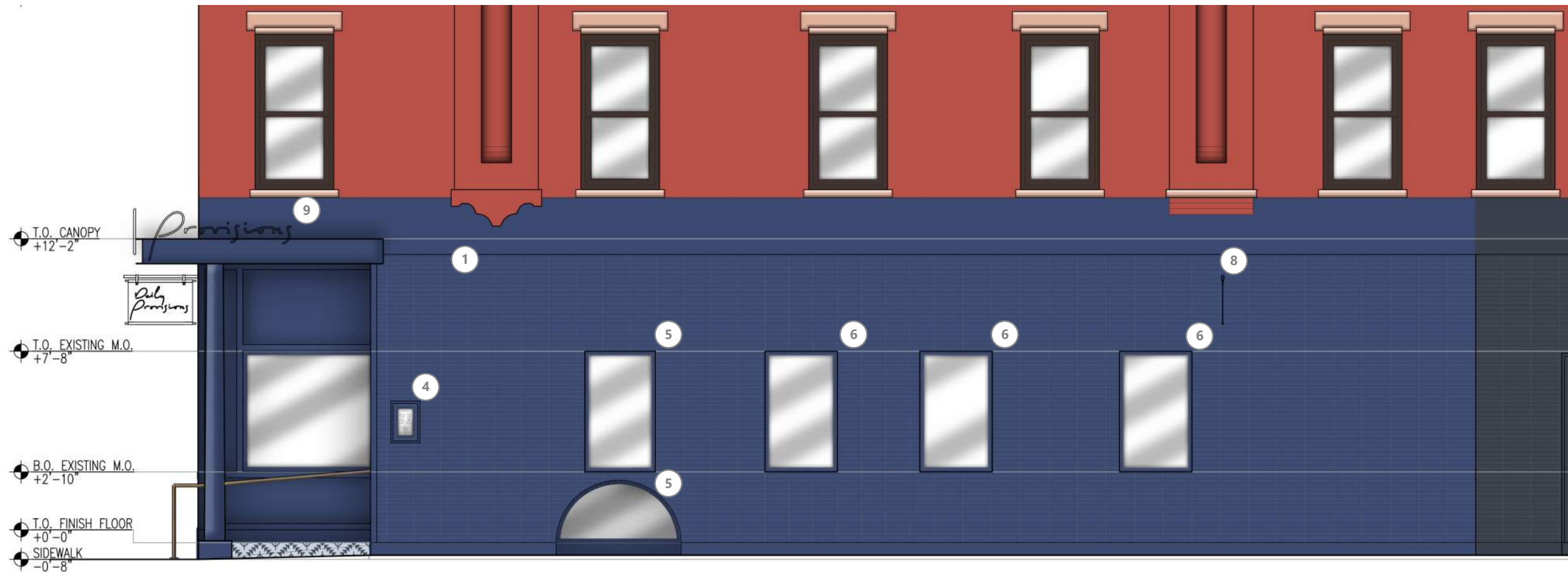

- ① Daily Provisions custom blue paint
- ② ADA entry ramp
- ③ brass railing
- ④ menu
- ⑤ existing window construction
- ⑥ new window construction
- ⑦ gooseneck fixture
- ⑧ blade sign
- ⑨ neon signage

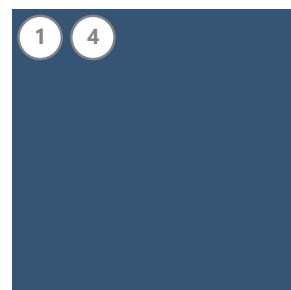

Daily Provisions blue paint



custom floor tile

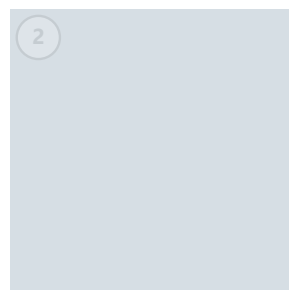

custom floor border tile

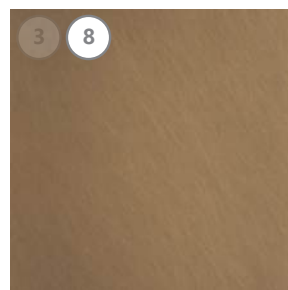

brass finish

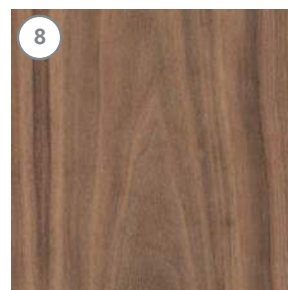

walnut finish



gooseneck fixture

Downing St. Elevation - Materials Palette

LANDMARKS PRESENTATION

DECEMBER 13TH, 2018

rockwellgroup



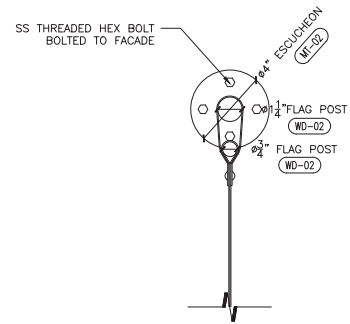
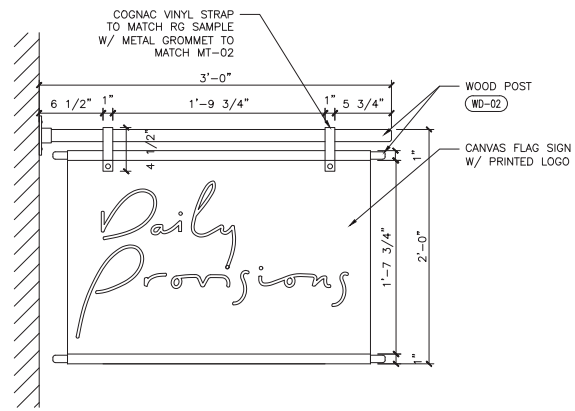

8 blade sign

7 gooseneck fixture

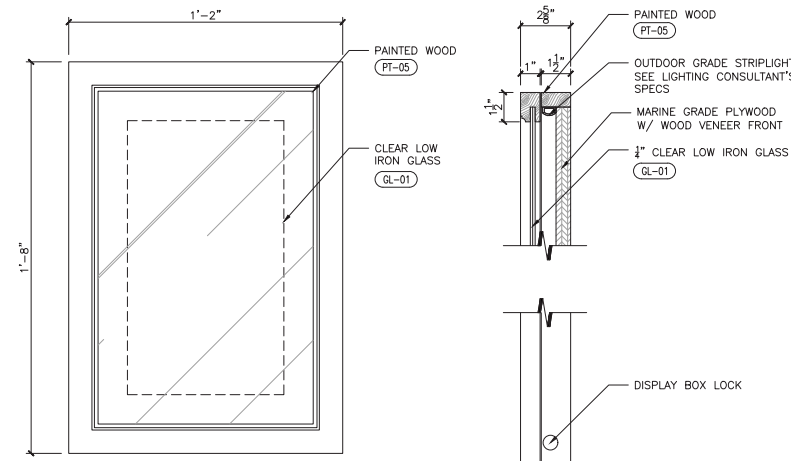

4 menu

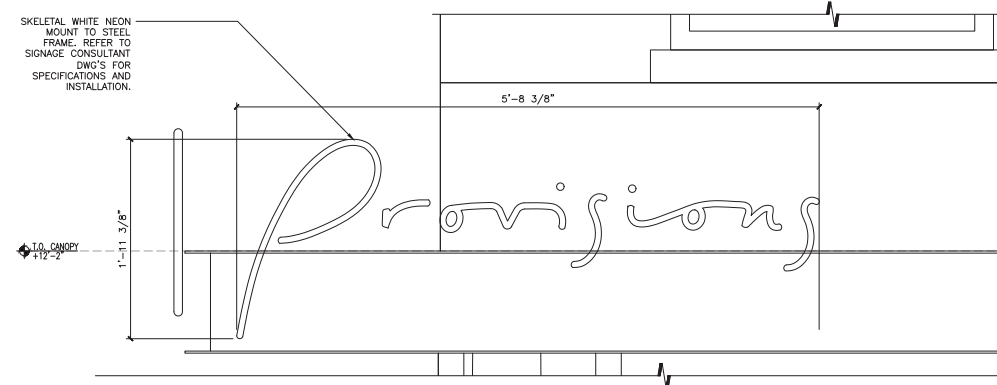
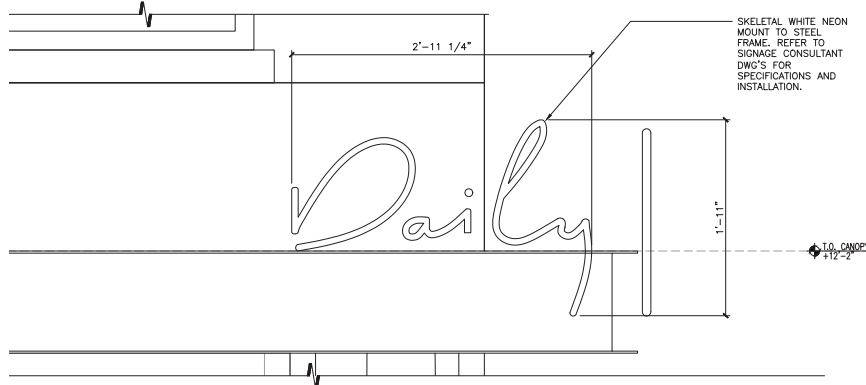

9 neon signage

- 1 Daily Provisions custom blue paint
- 2 ADA entry ramp
- 3 brass railing
- 4 menu
- 5 existing window construction
- 6 new window construction
- 7 gooseneck fixture
- 8 blade sign
- 9 neon signage

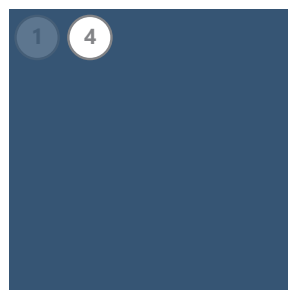

Daily Provisions blue paint



custom floor tile

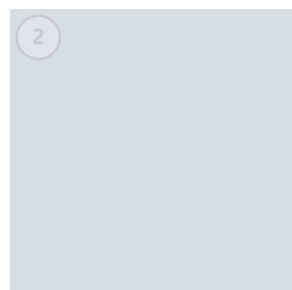

custom floor border tile

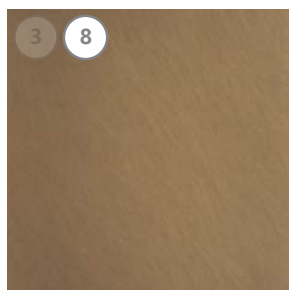

brass finish

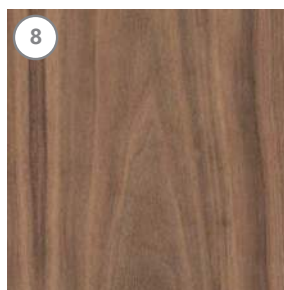

walnut finish



gooseneck fixture

Exterior Signage Details

LANDMARKS PRESENTATION

DECEMBER 13TH, 2018

THANK YOU!



UNION SQUARE
HOSPITALITY GROUP™

rockwellgroup